

# 常州市高瓴电机电器有限公司

## 磁阻式步进电机 28BF 36BF 45BF 55BF

接线图1

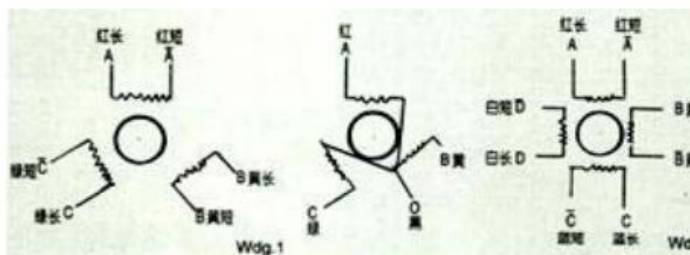

技术数据

型号	相数	步距角	电压	电流	保持转矩	空载启动频率	运行频率	接线图	备注
Model	No. of Phase	Step Angle (Deg.)	Voltage (V)	Current(A)	Holding Torque Nm(kg.cm)	No-load pull-in Frequency(Hz)	Pull-out Frequency(Hz)	Wdg	Notes
28BF001	3	3/6	27	0.8	0.017(0.18)	180 0		1	
36BF003-2	3	3/6	27	0.6	0.049(0.5)	190 0		1	
36BF003	3	1.5/3	27	1.5	0.078(0.8)	310 0		1	
45BF003-2	3	1.5/3	60	2	0.196(2)	370 0	12000	1	
45BF005-2	3	1.5/3	27	2.5	0.196(2)	3000		1	
45BF005-3	3	1.5/3	27	2.5	0.098(1)	290 0		1	
45BF008	3	1.5/3	24	0.2	0.118(1.2)	50 0		1	
45BC340C	3	1.5/3	12	0.4	0.118(1.2)	50 0		1	
55BF001	3	7.5/15	27	2.5	0.372(3.8)	75 0		1	
55BF003	3	1.5/3	27	3	0.666(7)	1800		1	
55BF004	3	1.5/3	2	3	0.49(5)	2200		1	
55BF004-2	3	1.5/3	30	0.5	0.49(5)	550		1	
55BF009	4	0.9/1.8	27	3	0.784(8)	2500		2	

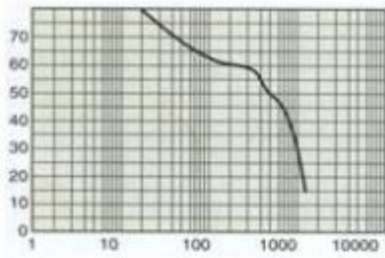

PULSE RATE(Hz)  
**28BF001**

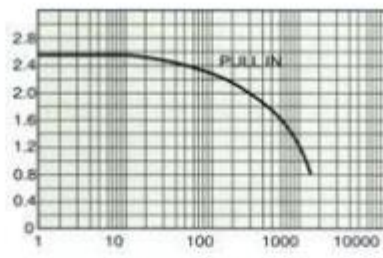

PULSE RATE(Hz)  
**36BF002-2**

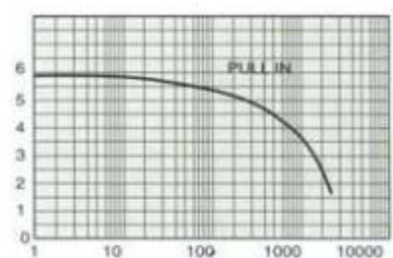

PULSE RATE(Hz)  
**36BF003**

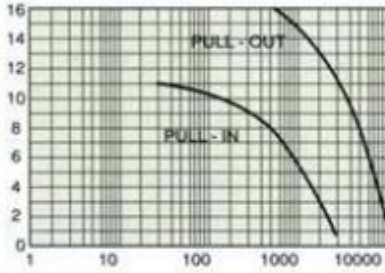

PULSE RATE(Hz)  
**45BF003-1**

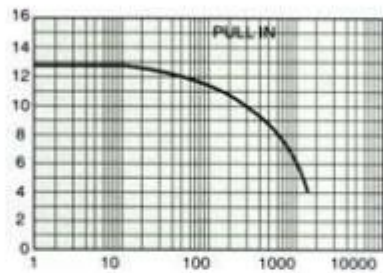

PULSE RATE(Hz)  
**45BF005-2**

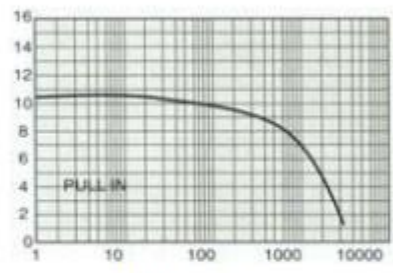

PULSE RATE(Hz)  
**45BF005-3**

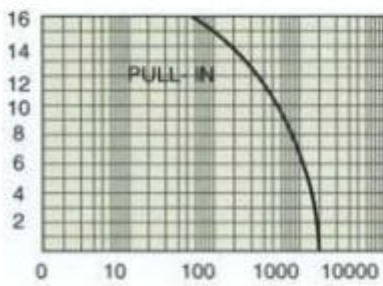

PULSE RATE(Hz)  
**45BF006**

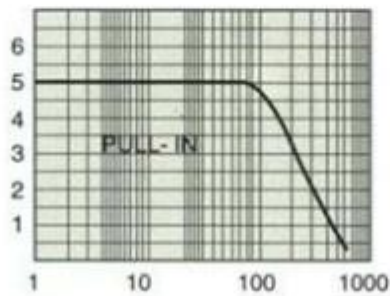

PULSE RATE(Hz)  
**55BF001**

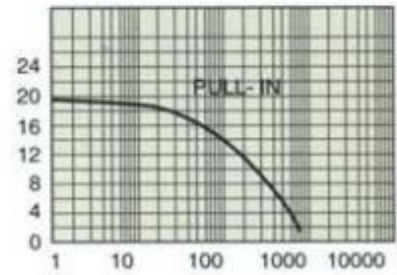

PULSE RATE(Hz)  
**45BF340C 45BF008**

地 址：江苏省常州市经开区芳渚村 360 号

电 话：0519-88350399

联系人：陶(总) 手 机：13776816562

网址：www.czgldj.com

邮 箱：tao-shulin@qq.com

地 址：江苏省常州市经开区芳渚村 360 号

电 话：0519-88350399

联系人：陶(总) 手 机：13776816562

网址：www.czgldj.com

邮 箱：tao-shulin@qq.com

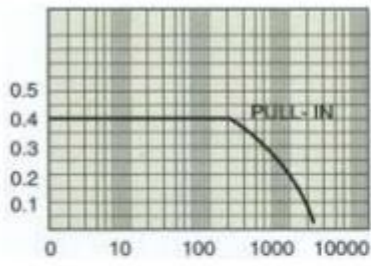

PULSE RATE(Hz)

**55BF003**

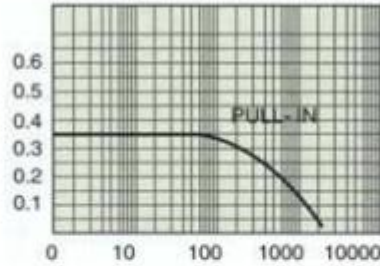

PULSE RATE(Hz)

**55BF004**

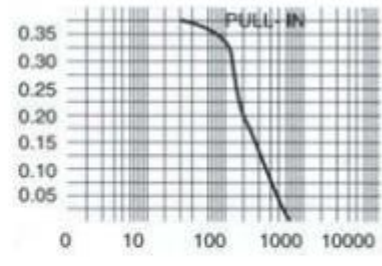

PULSE RATE(Hz)

**55BF004-2**

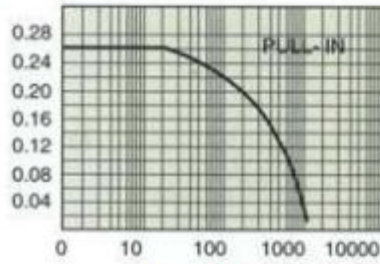

PULSE RATE(Hz)

**55BF005**

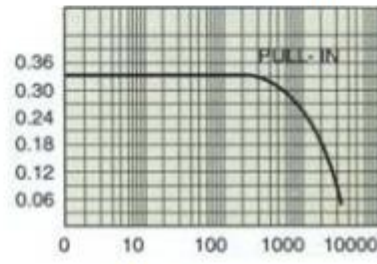

PULSE RATE(Hz)

**55BF009**

外形图

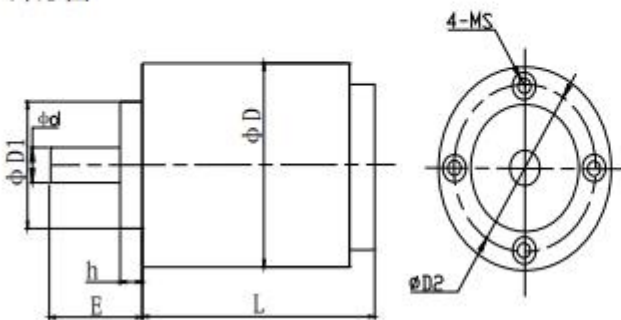

地 址：江苏省常州市经开区芳渚村 360 号

电 话：0519-88350399

联系人：陶(总) 手 机：13776816562

网址：www.czgldj.com

邮 箱：tao-shulin@qq.com

地 址：江苏省常州市经开区芳渚村 360 号

电 话：0519-88350399

联系人：陶(总) 手 机：13776816562

网址：www.czgldj.com

邮 箱：tao-shulin@qq.com